

šablony rámu 1:1

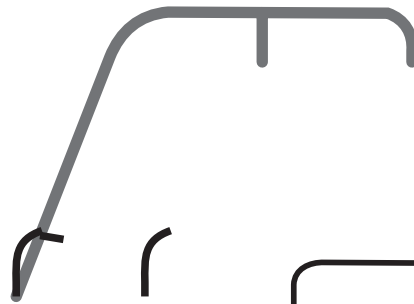

rám 2  
drát: 0,7 mm

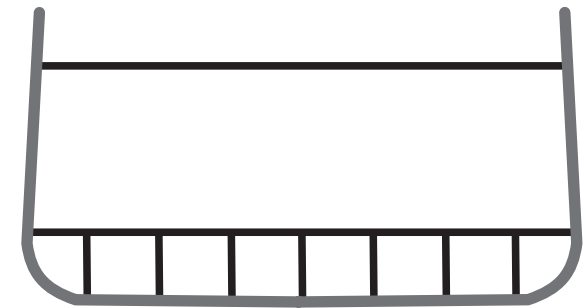
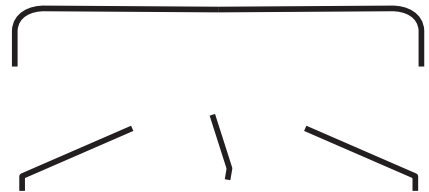

průměry drátů:  
1,5 mm (šedá linka)  
1 mm (černá linka)

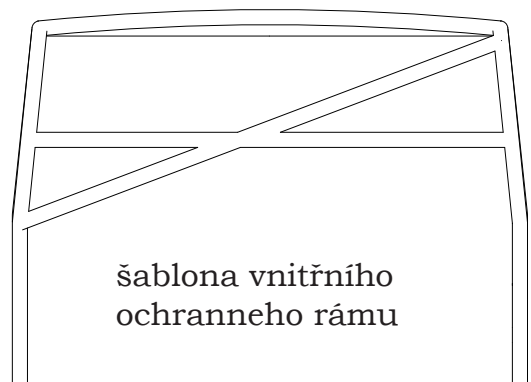
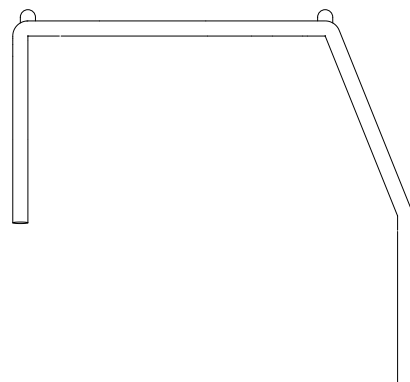
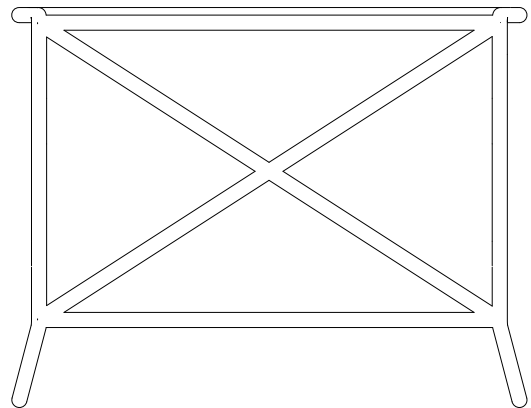
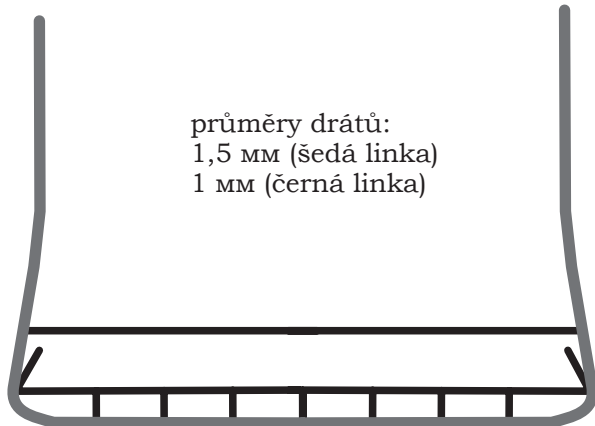

šablona vnitřního  
ochranného rámu



šablony stupaček  
drát 0,5 mm

šablony skel 1:1

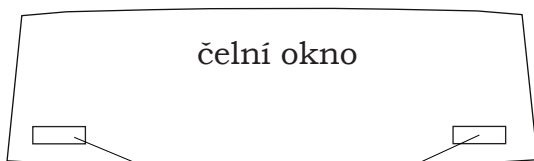

čelní okno

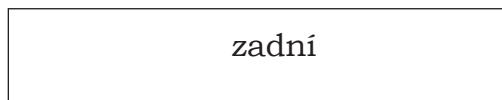

zadní



boční

nálepky na okna (díly 61)

\* - podlepit kartonem 0,5 mm

\*\* - podlepit kartonem 1 mm

+ - podlepit kancelářským papírem